

INSTRUCTION MANUAL

CONTROLLER OF
CENTRALIZED LUBRICATING SYSTEM

LC2MP-50

CONTENTS

Safety precautions	3
1. Overview	4
2. Outside surface	4
3. Connection method	5
4. Basic operation	7
5. Operation procedure	9
6. Error display	12
7. Warning management	13
8. Other errors	14
9. Maintenance	14

Safety precautions

This section describes the important points that require special attention for the safety when using this product. The safety precautions listed here are intended to prevent injury or damage to customers. In addition, the precautions are divided into two categories, "Warning" and "Caution", according to what may occur if the product is handled incorrectly. Be sure to follow all these instructions as they include important safety information.



In case where the product operation is mishandled ignoring this indication, a dangerous situation may occur leading to fatal or serious injuries.

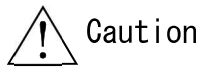

In case where the product operation is mishandled ignoring this indication, a dangerous situation may occur leading to injuries or property damage.



1. Turn off the power switch on the control panel before installing, removing, or repairing the product. Otherwise, the electric shock will happen.
2. Do not splash water on electrical components or remove the lid. Otherwise, a fire or electric shock may be caused.
3. Do not step on or pull the lubricating equipment, piping, etc. attached to the machine as footholds or as handrails. It may cause slips and falls or damage the lubrication system.
4. Do not disassemble or remodel the lubrication equipment. Please consult us if necessary. In the unlikely event that maintenance work is required at the site, it should be performed by a person with specialized knowledge.

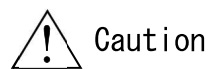

1. Use protective equipment when handling grease. If it gets in your eyes or touches your skin, it may cause visual impairment or inflammation.
2. Carry out periodic inspections of the lubrication system (grease consumption control, operation check, etc.). If you forget inspections, it may cause machine failure due to seizure in bearings, etc.
3. Use the product within the rated specifications and the usable environmental conditions. Using the product outside of the rated specifications or in a special atmosphere (next to fire, explosive atmosphere, etc.) may cause mechanical failure or fire.

1. Overview

This is a controller for controlling the LUBMAX motor driven grease pump and distributing valve of a single-pipe parallel lubricating system.

2. Outside Surface

2-1. Name of parts

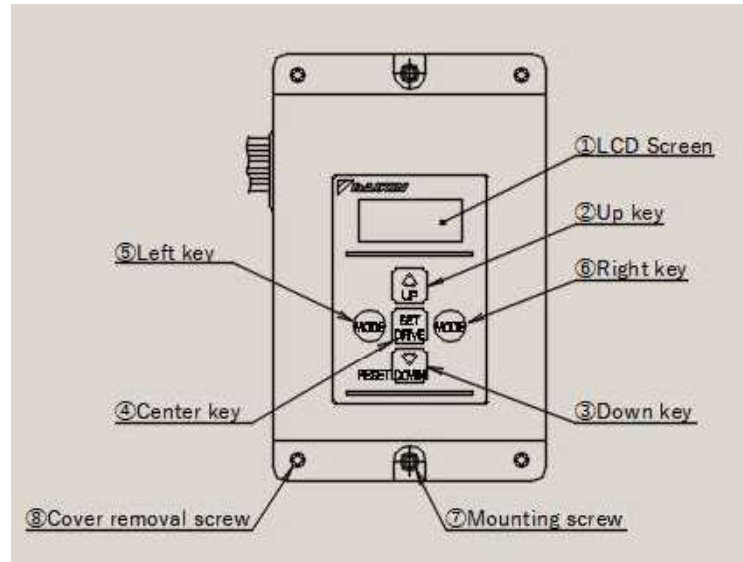

2-2. Function

① LCD screen

The display shows maximum 8 characters and 2 rows of alphanumeric characters. The semi-transmissive LCD panel with backlight provides excellent visibility regardless of the brightness of the surroundings.

② Up key

Used for various settings.

③ Down key

Used to reset various settings and errors.

④ Center key

Used for determination of selected value and Optional Operation.

⑤ Left key

Used together with the Right key to enter configuration mode.

⑥ Right key

Used together with the Left key to enter configuration mode.

⑦ Mounting screw

M5 tap (embedded nut).

⑧ Cover removal screw

The fuse on the back of the internal board can be replaced by removing the tapping screws on the four corners. (See page 14)

3. Connection method

3-1. Installation

DO NOT installing the controller in the following locations.

- A place where water is directly splashed.
- Places exposed to wind and rain.
- Places exposed to direct sunlight.

3-2. Overall wiring diagram

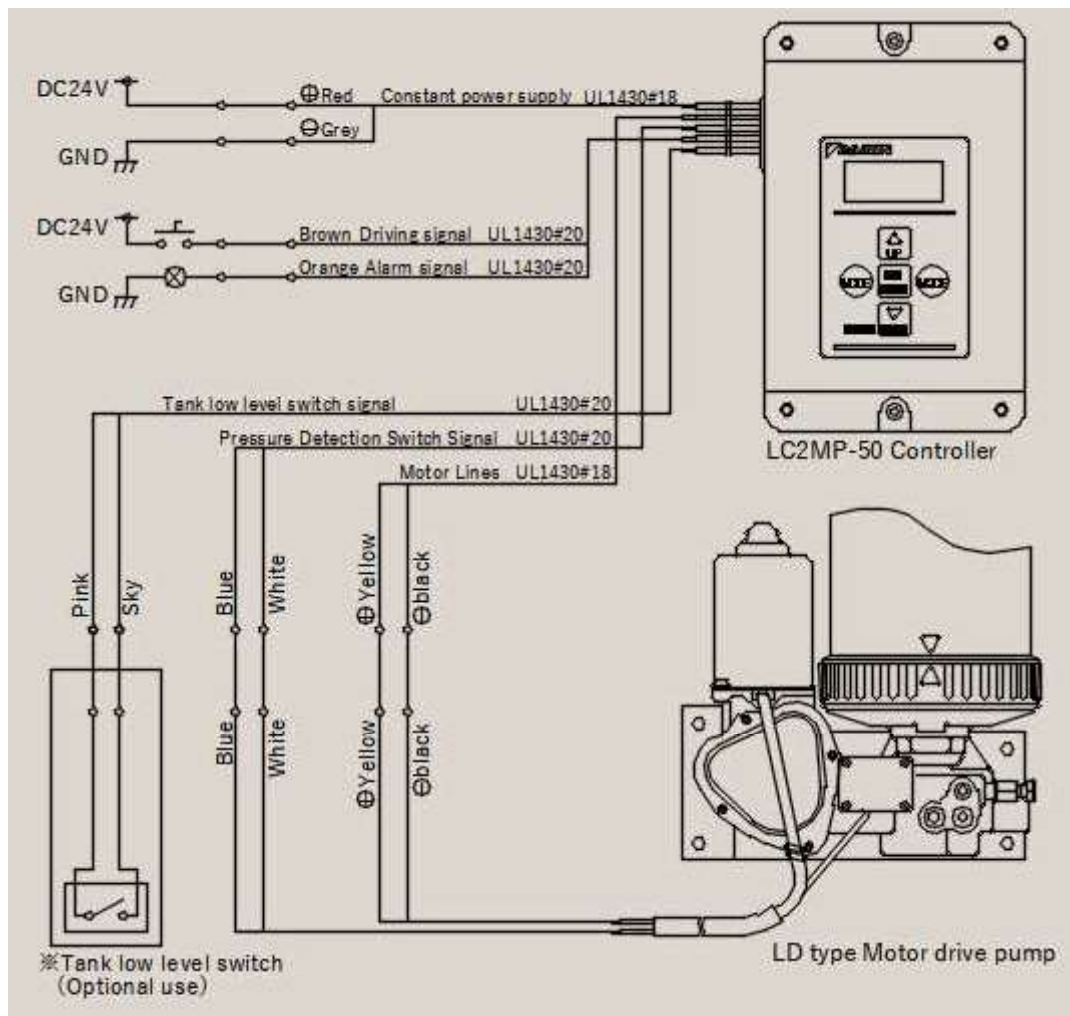

*Tank low level switch can only be used for the tank that corresponds to the switch.

(See page 11)

3-3. Details of I/O signal

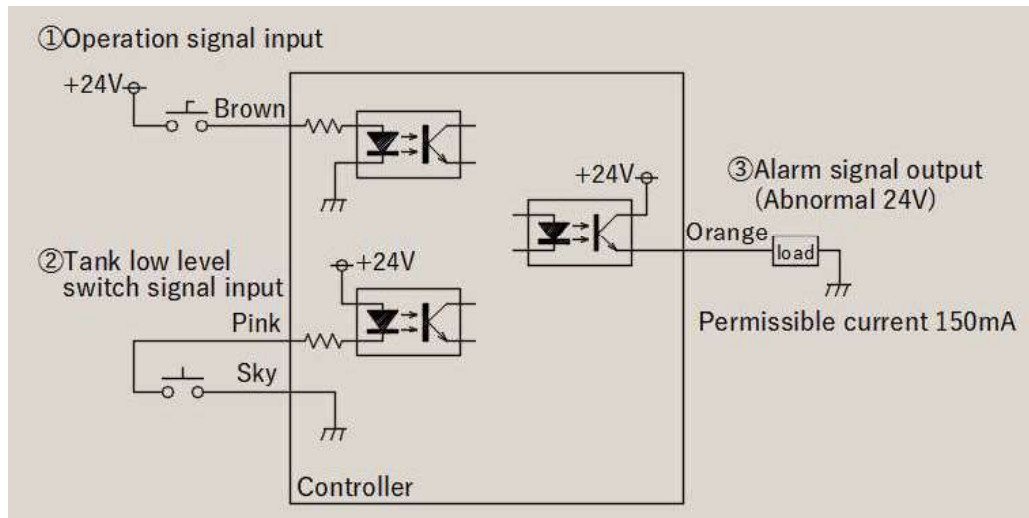

For safer and more convenient use, it is recommended to connect all signal lines, but minimum automatic operation is possible even if nothing other than the operation signal input line is connected. Insulate the ends of unused wires.

① Operation signal input

+24V input/disconnection starts/stops the controller.

② Tank low level switch signal input (see pages 11 and 12)

Connect to the switch that detects the low level of the tank. When the switch is turned ON, the screen is displayed, and an alarm signal is output.

③ Alarm signal output (see page 12)

Outputs +24V when an error occurs.

Failures can be notified to the outside by using this signal. Since the allowable current is 150mA, please use a suitable load or operate it via a relay when using a large load.

4. Basic operation

This controller controls the operation of the grease pump according to the following operating procedures and manages the entire lubrication system.

4-1. Automatic operation

Automatic operation is the basic usage of this controller. Lubrication is automatically performed at set time intervals.

	Status	Descriptions	
1	Power switch ON	When the power is turned on, the controller waits for the input of the operation signal. There is no display on the LCD at this point.	
2	Lubrication interval time Measurement	When the operation signal is input, the controller starts up, measuring the lubrication interval timer until the next lubrication, and enters the lubrication standby state.	
		LCD screen <div style="border: 1px solid black; padding: 5px; width: fit-content; margin: 0 auto;"> WAITING 04 : 48 : 45 </div>	The LCD counts down the time until the next lubrication. (hh : mm : ss) ※The time displayed on the left is an example.
3	Lubrication (Pressurization)	The pump operates and lubrication starts when the lubrication interval time reaches the preset time.	
		LCD screen <div style="border: 1px solid black; padding: 5px; width: fit-content; margin: 0 auto;"> DRIVING 02 : 16 </div>	The elapsed lubricating time is displayed on the LCD. (mm : ss) ※The time displayed on the left is an example.
4	Pressure retention	The system pressure is monitored by the pressure detection switch built into the pump, and when the specified pressure is reached, the pump stops and waits while maintaining the pressure in the supply line.	
		LCD screen <div style="border: 1px solid black; padding: 5px; width: fit-content; margin: 0 auto;"> PRS/KEEP 03 : 25 </div>	The elapsed lubricating time will be displayed on the LCD continuously. (mm : ss) ※The time displayed on the left is an example.

5	Intermittent depressurization	Reoperates the pump when system pressure drops during pressure hold. After that, the ON/OFF of the pump is controlled so that the pressure is always maximized.	
		LCD screen <div style="border: 1px solid black; padding: 2px; display: inline-block;"> DRIVING 03 : 56 </div>	The elapsed lubricating time will be displayed on the LCD continuously. (mm : ss) ※The time displayed on the left is an example.
6	Depressurization	When the system pressure is maintained for the set lubrication time, the motor of the grease pump rotates in reverse and the depressurization mechanism operates to release the pressure in the system and complete lubrication.	
		LCD screen <div style="border: 1px solid black; padding: 2px; display: inline-block;"> PRESSURE RELEASE </div>	When depressurization is completed, it returns to the state of lubrication interval time measurement, and repeats 2 to 6 thereafter.

4-2. Optional operation

A process from lubrication to depressurization can be performed once at any timing independent of the timer.

Press the Center key.



	Status	Descriptions	
—	Optional operation	A process from lubrication to depressurization can be performed once. After completion of the lubrication, the integrated value of the lubricating interval timer is reset, and measurement of the timer for the next automatic operation starts.	
		LCD screen <div style="border: 1px solid black; padding: 2px; display: inline-block;"> DRIVING 02 : 16 </div>	The elapsed lubricating time will be displayed on the LCD. (mm : ss) ※The time displayed on the left is an example.

4-3. End of operation

To finish the operation, turn off the operation signal. When the operation signal of the main machinery is turned OFF, the controller stops the operation regardless of whether lubrication is in progress or standby. After depressurization, it

memorizes the integrated time of the lubricating interval timer then shuts off the power supply to itself automatically. It is not necessary to turn off the constant power supply each time, but even after the constant power supply to the controller is turned OFF, the integration content of the lubricating interval timer and settings are held in controller's memory, when the next operation signal is input, the timer will count cumulatively from the last time it was shut off. However, if the constant power supply is cut off before or at the same time as the operation signal's cut off, the controller doesn't memorize them. If the operation signal is interrupted while lubricating, lubrication will start immediately when the next operation signal is input.

5. Operating procedure

This controller is used by setting the following three values.



5-1. Description of set item







Setting items	Contents	Values	Descriptions
Lubrication interval time	Operation interval until next lubrication	1 ~ 24hr. Can be set in units of one hour (※1) (Initial value: 1 hour)	The optimal lubrication interval varies depending on the shape of the lubrication points, load, operating time, etc. Set so as not to cause shortage of lubricant.
Lubrication time	Time limit per lubrication	1 ~ 30min. Can be set in units of one minute (Initial value: 2 minutes)	If one lubrication is not completed within the setting time, an alarm signal will be output. Set the time with a little extra before the normal lubrication is completed. The time required for a lubrication is greatly affected not only by the number of lubrication points and the discharge quantity of distributing valves, but also by the diameter and length of the pipe of the supply line. It also varies depending on temperature and grease consistency. Set it while measuring the time actually.



Limit number of times for lubrication	Lubricating times until the tank is considered empty and an alarm signal is output	0 and 20-300 times Can be set in units of 10 times (Initial value: 20 times) If set to 0, this function is disabled (the tank empty alarm will not be output due to the number of lubrications)	The amount of grease consumed per lubrication is determined by the number of lubrication points and the discharge quantity of distributing valves. You can calculate how many times you can lubricate from the capacity of the tank (cartridge), so by setting the appropriate number of times, you can simulatively display that the tank is empty. Since there is an error in the discharge amount of the distributing valves, there may be a discrepancy from the calculated value.
---------------------------------------	--	--	---

※1 1 hour and 30 minutes also can be set.

5-2. How to set

When the controller is activated and in the standby state, pressing the left and right keys   at the same time for 1 second or more shifts to the lubrication interval time setting mode.

Setting items	Descriptions
Lubrication interval time	<p style="text-align: center;">LCD screen</p> <p>(Display example) WA I T I N G (Flashing) 0 6 : 0 0 (6 hours)</p> <p> Select the time with the up and down keys.  Determined with the center key. At the same time,  it shifts to the lubrication time setting mode.</p>
Lubrication time	<p style="text-align: center;">LCD screen</p> <p>(Display example) D R I V I N G (Flashing) 0 5 : 0 0 (5 minutes)</p> <p> Select the time with the up and down keys.  Determined with the center key. At the same time, it shifts  to the Limit number of times for lubrication setting mode.</p>

Limit number of times for lubrication	(Display example)	LCD screen <div style="border: 1px solid black; padding: 5px; display: inline-block;"> EMPTY 100 </div>	(Flashing) (100 times)
	  	Select the number of times with the up and down keys. Determined with the center key. At the same time, it returns to the standby state.	

■ Special case for setting of lubrication interval time

- The measurement of the lubrication interval timer is interrupted during the setting mode. Therefore, automatic operation will not start during setting mode.
- Even if the lubrication interval timer setting is changed, the memory of the elapsed time up to that point remains.

Example 1) If the current setting value of lubrication interval time is 5 hours and the elapsed time is 3 hours, and the lubrication interval time is changed to 4 hours, measurement will continue after 3 hours have passed and lubrication will start in the remaining 1 hour.

Example 2) If the current setting value of lubrication interval time is 5 hours and the elapsed time is 4 hours, and the lubrication interval time is changed to 3 hours, the set time has already passed, and lubrication starts immediately after the setting is completed.

■ Exceptions for setting the limit number of times for lubrication

- The number of lubricating times that has passed remains until it is reset.

Example 3) If the current setting of limit number of times for lubrication is set to 100 times and it is changed to 200 times after 80 times have passed, counting continues from 80 times and EMPTY is displayed after 120 times.

Example 4) If the current setting of limit number of times for lubrication is 200 times and it is changed to 100 times after 120 times have passed, the set number of times has already passed, and EMPTY is displayed after the setting mode ends.

■ Regarding Low-level switch connection

This controller has a function to directly receive and display the tank empty signal by connecting to the tank low level switch. As a result, it is possible to display a more accurate tank empty timing instead of simulatively showing the empty tank

with the lubricating limit function.

In order to use this function, non-standard tank compatible with a low-level switch is required. (Please note that compatible models are limited.) For using this function, connect the low level switch line of the controller to the low level switch of the tank. This function is enabled when the limit number of times for lubrication limit is set to 0.

5-3. Setting image

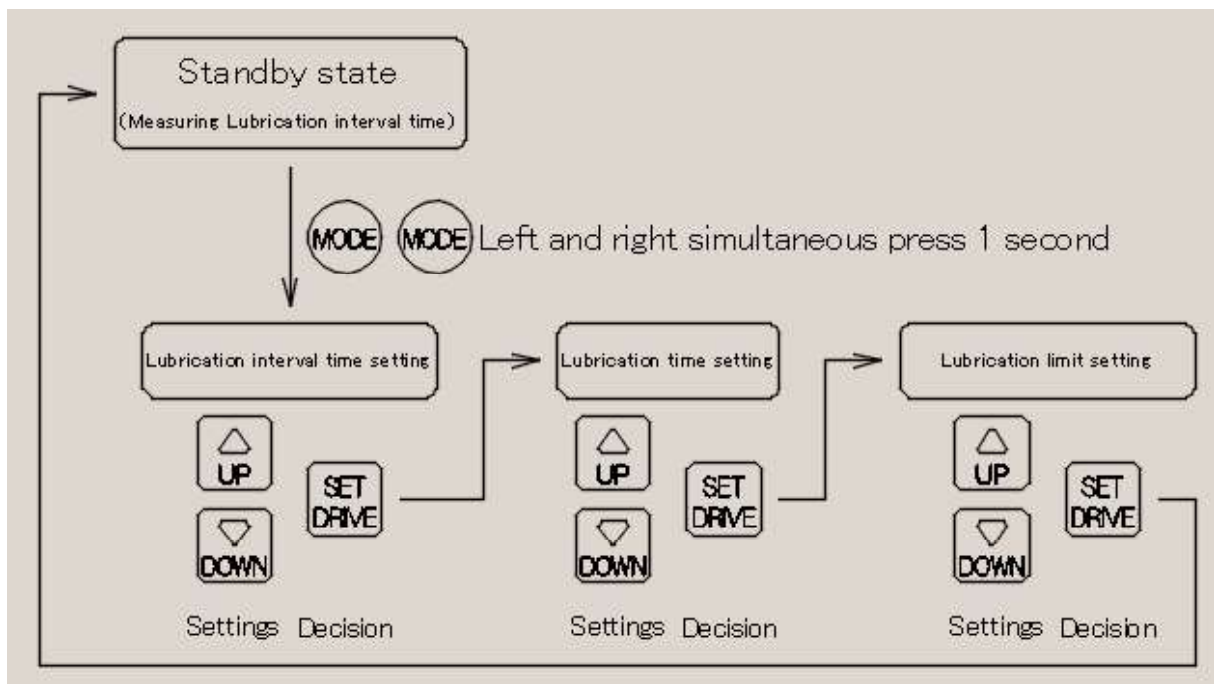

6. Error display

If an error occurs in the system, the followings are displayed depending on the situation.

Item	Phenomenon	LCD screen	Alarm output	
Abnormal pump pressurization	The pressure does not rise to the specified pressure within the pump operating time.	ERROR TIME UP (Flashing)	24V Output	※ 1
Abnormal depressurization	Pressure does not release even after depressurization.	ERROR RELEASE (Flashing)		
Abnormal pressure detection	LS for pressure detection is activated before the lubrication system starts.	ERROR PRESS/SW (Flashing)		

Overload error	An overload (overcurrent) of the pump motor was detected.	ERROR OVERLOAD (Flashing)	
Tank empty	The actual number of lubrication times has reached the set lubrication limit number. In case using a low level switch, the low level switch has been activated.	EMPTY 04 : 48 : 45 (Flashing)	※2

*1 The system will stop.



*2 A warning signal is output, but the system does not stop. Counts down the time until the next lubrication while displaying "EMPTY". Promptly check the remaining amount of grease.

7. Warning management

If the error described in 6 above occurs, refer to the following to remove the cause of the error and reset.

	Item	Factor	Process
1	Abnormal pump pressurization	<ul style="list-style-type: none"> ▪ Air entering the pump and supply pipe. ▪ Insufficient grease in the tank. ▪ Grease leakage from the supply pipe. ▪ Lack of lubricating time. ▪ Abrasion of check packing. 	Perform air bleeding. Fill Grease. Inspect and retighten pipe connections. Set the lubrication time to an appropriate value. Replace check packing.
2	Abnormal depressurization	<ul style="list-style-type: none"> ▪ Abnormal pressure release mechanism in the pump. ▪ Abnormality of the pressure detection switch in the pump. 	Check the depressurization mechanism. *1 Check the pressure detection switch.
3	Abnormal pressure detection	<ul style="list-style-type: none"> ▪ Abnormal pressure release mechanism in the pump. ▪ Abnormality of the pressure detection switch in the pump. 	Check the depressurization mechanism. *1 Check the pressure detection switch.

4	Overload error	<ul style="list-style-type: none"> ▪ Short circuit of motor wiring, etc. ▪ Foreign matter is mixed in the pump piston. ▪ Use in extremely low temperatures. 	<p>Check wiring and connectors.</p> <p>Check pump. *1</p> <p>Change the usage environment.</p>
5	Tank empty	<ul style="list-style-type: none"> ▪ The number of lubricating times has been reached. ▪ Grease consumption. 	<p>Fill grease or replace cartridge.</p>

① For 1 to 4, press the  key to reset. If the factor of the error has been removed,  will be displayed and the error will be reset. ERROR continues to be displayed until reset, and operation and timer counting are not performed.

② To reset the tank empty alarm when the lubricating limit has been reached in 5, similarly press and hold the reset key for 5 seconds or longer.  will be displayed, and the cumulative number of lubrication times will be reset.

The lubrication limit can be reset not only while EMPTY is displayed, but also while stand-by status. It is recommended to reset after replenishing the grease (replacing the cartridge).

③ If the low level switch is used in 5, the grease is consumed and the low level switch operates. When the grease is replenished and the low level switch is released, the EMPTY display will be canceled (the reset key is not used).

*1 If error occur frequently or continue, please contact us.

8. Other errors

Phenomenon	Factor	Process
Nothing is displayed on the LCD screen.	Loss of power supply, operation signal voltage, voltage drop.	Check power supply and wiring.
	Blown fuse.	Fuse replacement. (See next page.)

9. Maintenance

- ① Please check the display of the controller on a daily basis to confirm that it is operating normally so that it will not be left in an error status. Pay special attention if the controller is installed in a hard-to-see location.
- ② Periodically check for looseness of mounting screws, disconnection of connectors, disconnection of lines, short circuits, etc.
- ③ The controller has a built-in fuse for circuit protection. When replacing, remove the opening screws (see page 4) at the four front corners. The fuse used is a 10A mini fuse for automobiles.
 - Do not disassemble for purposes other than fuse replacement.
 - If you open the housing, the board will be exposed, so please take measures such as removing the battery or turning off the power at all times in advance.
 - The fuse is attached very tightly. Please remove it slowly and carefully.
 - Many precise electronic parts are mounted on the board. Be careful not to damage or disconnect the wire.
 - When reassembling the housing, be careful not to let the packing protrude or get foreign objects caught.
 - When reinstalling the screws, be careful not to crush the threads on the housing side.



Caution Improper handling can damage the equipment.

END